

Engineering Skills – Creativity Lab: Wind Turbine

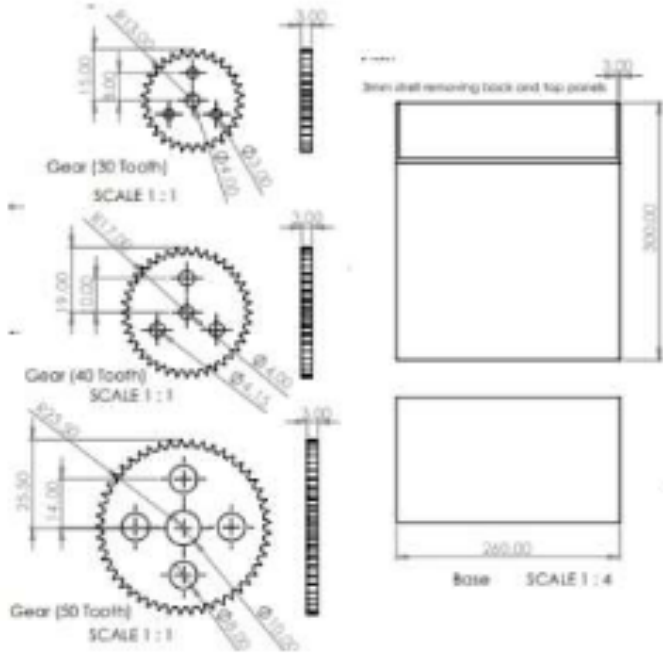

The structure was half filled with concrete (£5) to support it and to withstand the wind force: weight = 2.24kg

The motor was placed inside the structure and is supported by a small stack of foam board

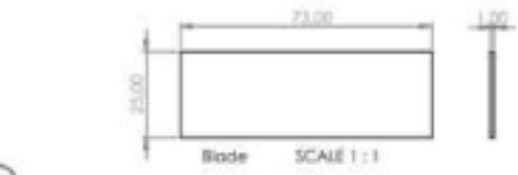
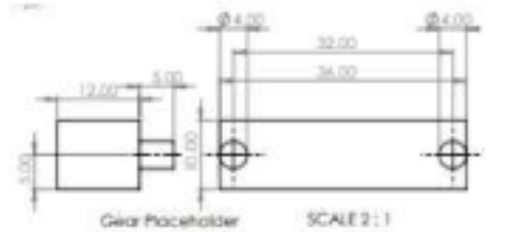
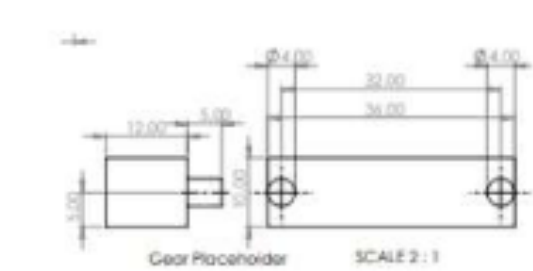
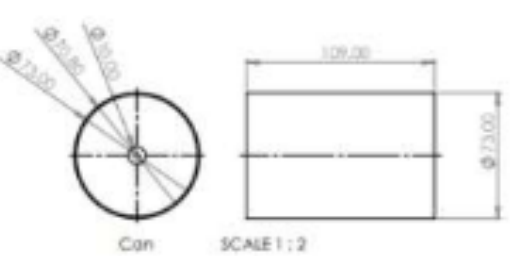
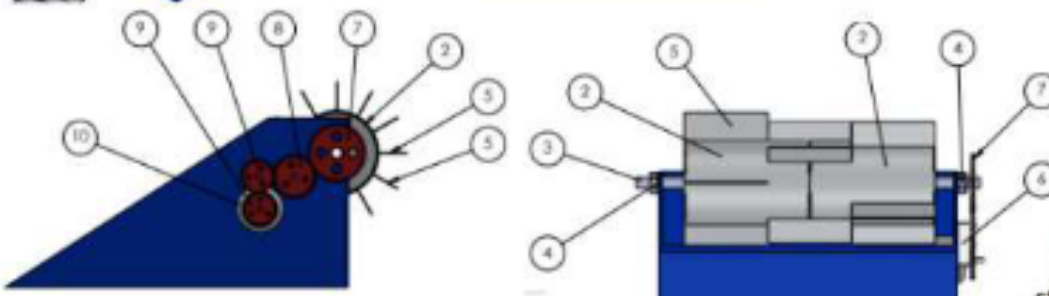
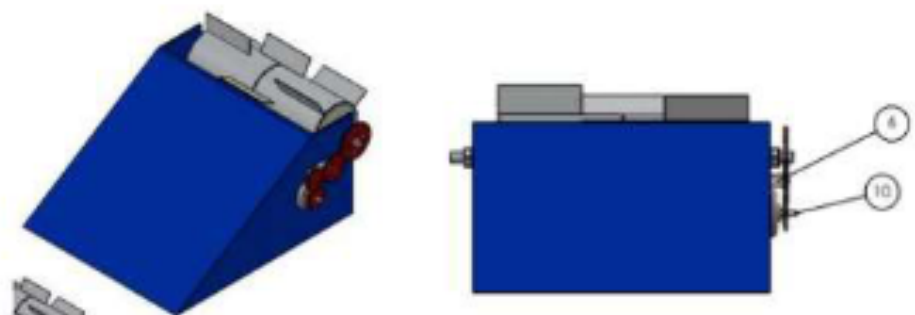

The force of the wind causes the blades to rotate about the axis of the shaft, resulting in the rotation of the gears

The rotation of the gear attached to the motor results in the production of a voltage. By connecting the motor to an ammeter, the motor produced 0.7v therefore the structure successfully harnessed the wind energy

